

CP-6



COMPACT, HIGH PERFORMANCE INDOOR/OUTDOOR LOUDSPEAKER

The Klipsch Compact Performance CP-6 mountable cabinet speaker, with its weather-resistant design, is as much at home on the patio as it is placed on a shelf or mounted on the wall indoors. The proprietary 90° x 90° Tracrix® Horn provides for unmatched low-distortion clarity and detail while the long-throw woofer combines with front-firing ports for amazingly powerful low frequency response wherever they are located. Traditional Klipsch efficiency provides maximum output with minimum wattage.

QUICK, EASY INSTALLATION

The CP-6 makes a highly aesthetic statement with its smaller size and ability to mount closer to a wall or even be tucked into a corner with its V-shaped rear profile. Tool-free angle adjustment makes positioning a breeze. The unique, solid mounting bracket assures a fast, easy, one-screwdriver installation. Front speaker wire terminals combined with a pull-through wire channel provide a quick connection with an uncluttered look. The CP-6 will also look great placed on a shelf or stand without using the supplied bracket.

MULTIPURPOSE DESIGN

The Klipsch CP-6 can function as stereo mains or surrounds or be mounted outdoors for warmer weather enjoyment with its solid, mineral-filled cabinet and stainless steel hardware. Sold in pairs and offered in Black or White with the ability to custom paint, the CP-6 complements any indoor or outdoor décor.

SPECIFICATIONS	CP-6
Frequency Response ¹	70Hz-22kHz +3/-6 dB
Power Handling ²	75 w (300 peak)
Maximum Continuous Output ³	111dB
Sensitivity ⁴	94 dB @ 1 watt/1 meter
Nominal Impedance	8 ohms
Tweeter	.75" (1.9cm) aluminum dome tweeter
High Frequency Horn	90° x 90° Tracrix® Horn
Woofer	5.25" (13.3cm) long-throw IMG woofer
Crossover Frequency	3kHz 12dB octave
Enclosure Type	Bass-reflex via dual front-firing ports
Enclosure Material	Anti-resonant, mineral-filled PPC; paintable, weather resistant
Grille	Powder-coated aluminum w/rotatable logo
Terminals	Front baffle mounted accessed via rear pull-through
Speaker Weight	5.8 lbs. (2.6kg)
Speaker Dimensions	11.0"(27.9cm) H x 7.0"(17.8cm) W x 6.1"(15.5cm) D
Speaker Dimension w/ Wall Mount	11.0"(27.9cm) H x 7.0"(17.8cm) W x 6.9"(17.5cm) D
Other Mounting Options	1/4", 20-thread insert on cabinet rear
Finishes	White/Black enclosure and grille
Wire Gauge Accommodated	up to 16AWG
Sold As	Speaker pairs
Included in Carton	Speakers (x2), Grilles (x2), Brackets (x2), Manual, Mounting Template, Bracket Retaining Screws (x4), Safety Instructions, Grille Removal Tool
Carton Dimensions	15"(380mm) H x 19.5"(496mm) W x 10.6"(268mm) D
Total Carton Weight	15.21 lbs.(6.9kg)
Item Number	1060387 (white), 1016297 (black)
UPC	743878027037 (white), 743878025989 (black)
Built From	2014

Klipsch®
KEEPERS OF THE SOUND

3502 Woodview Trace Indianapolis, IN 46268 | klipsch.com

All specifications are subject to change without notice.

©2014 Klipsch Group, Inc. Klipsch is a wholly-owned subsidiary of VOXX International Corporation

¹ 3M anechoic

² IEC 268-5 filtered pink noise with 6dB crest factor

³ Calculated at 1M at power handling power input

⁴ SPL at 1M, anechoic with 2.83V input

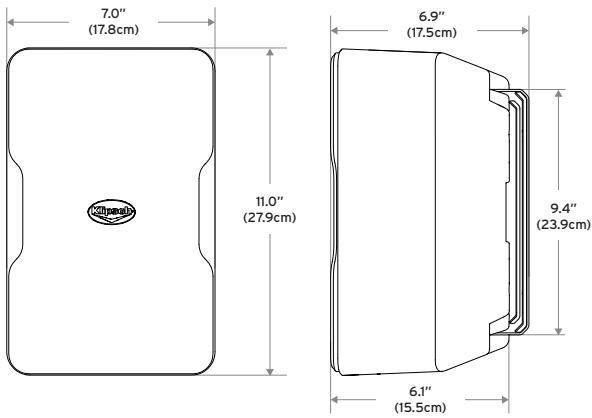

TOOLS NEEDED FOR CP-6 INSTALLATION:

- a) Level
- b) One pencil
- c) 1 Philips #2 screwdriver OR One Power Drill with A LOW TORQUE SETTING and a Philips #2 screwdriver bit
- d) IF WALL MOUNTING: Four #10 or #12, 2.5-3" (4-5cm) Pan head Screws (Two for each speaker bracket) for mounting into wall stud OR Four minimum 10 lb. (5kg) Wall Anchors if stud-mounting is unavailable

SUGGESTIONS ON CONNECTING TWO PAIRS OF CP-6'S TO ONE AMPLIFIER/RECEIVER:

Klipsch CP-6 speakers are rated at 8 Ohms Nominal Impedance. If connection of TWO PAIRS to one amplifier or receiver is desired, the following connection methods are recommended:

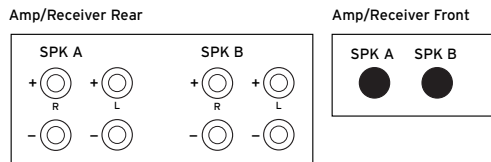

If your amp/receiver has separate connections for two speaker pairs, connect the two pairs of CP-6's to the two speaker terminal sets. Depending on your amp/receiver, either both pairs, or just one pair, will play at the same time.

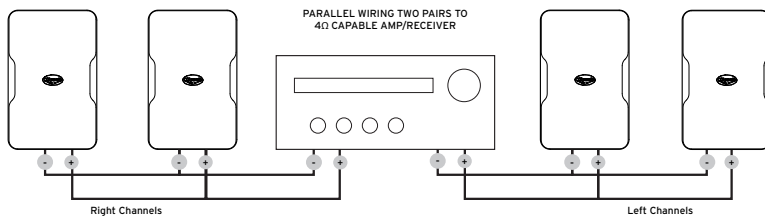

If your amp/receiver does not have separate connections for two speaker pairs, connect CP-6's to the single set of speaker terminals in parallel as shown. Your amp/receiver must be rated to 4 Ohms to make this connection.

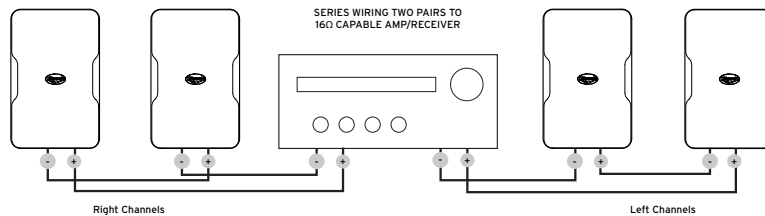

If your amp/receiver cannot drive a two-pair, 4 Ohm load above, connect both pairs of CP-6's to the single set of speaker terminals in series as shown. This will lower the volume sent to all speakers.

SUGGESTIONS ON PLACEMENT OF KLIPSCH CP-6 SPEAKERS:

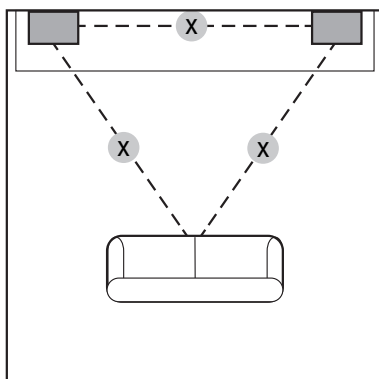

STEREO ROOM PLACEMENT EXAMPLE
(aim speakers to main listening area)

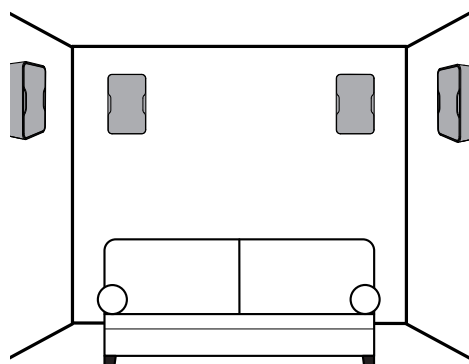

AS SURROUND SPEAKERS ROOM PLACEMENT EXAMPLE

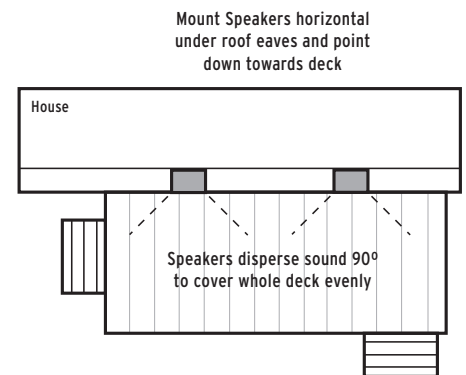

OUTDOORS TO COVER A DECK/PATIO WITH SOUND
(aim speakers down to main listening area)